



---

## CRICKET

### CRICKET

The Official Special Olympics Sports Rules for Cricket shall govern all Special Olympics competitions. As an international sports program, Special Olympics has created these rules based upon International Cricket Council (ICC) rules for cricket found at <http://icc-cricket.yahoo.com/>. ICC or National Governing Body (NGB) rules shall be employed except when they are in conflict with the Official Special Olympics Sports Rules for Cricket or Article I. In such cases, the Official Special Olympics Sports Rules for Cricket shall apply.

### SECTION A—OFFICIAL EVENTS

The following is a list of official events available in Special Olympics.

The range of events is intended to offer competition opportunities for athletes of all abilities. Programs may determine the events offered and, if required, guidelines for the management of those events. Coaches are responsible for providing training and event selection appropriate to each athlete's skill and interest.

- 1) Cricket Skills Test
- 2) Team Competition

### SECTION B— GENERAL RULES

#### Law 1: Fielding a Team

- a. A match is played between two sides, each of eleven players, one of whom shall be the captain.
- b. Any side unable to field at least eight players shall forfeit the match. The match shall be forfeited at the opposing captain's option any time 15 minutes after the scheduled starting time.

#### Law 2: The Game

- a. A match consists of 2 innings, one per team, each of 20 overs. Each player except the wicketkeeper bowls 2 overs, i.e.  $10 \times 2 = 20$  overs. Where a bowler is unable to complete an over due to injury or illness, the coach should nominate their 9th or 10th designated bowler to complete the remaining balls/overs.
- b. All bowling must be with an over arm action.
- c. A match will be won by the side which, at the end of both innings, has the highest Team Score. Team Score is calculated by dividing the total number of team runs by the number of wickets that are lost in the 20 overs.
- d. In the event of the Team Scores being equal, the winner shall be:
  - 1) The team that lost the least number of wickets
  - 2) The team that scored the most 6's
  - 3) The team that scored the most 4's
  - 4) The team that conceded the fewest extras
  - 5) If both teams are still equal, then the winner will be decided by the toss of a coin

#### Law 3: Control of Play

- a. Before the match, two umpires shall be appointed to control the game with absolute impartiality, as required by the laws.
- b. No umpire shall be changed during the match without the consent of both team coaches.
- c. The umpire shall be the sole judge of fair and unfair play.
- d. In all disputes, the ruling umpire's decision is final.



## CRICKET

### Law 4: Substitute Players

- a. Substitutes shall be allowed in the event of injury or illness during play.
- b. Substitutes shall be allowed to bat and bowl in the place of the person they replace.
- c. A substitute shall not be allowed to be a wicketkeeper without the consent of the opposing Team Coach.
- d. Runners are allowed for injured players.
- e. A substitute may be used due to the late arrival of a registered starting player; but a substitute will not be allowed to bat or bowl.

### Law 5: No-Balls

- a. A no-ball occurs when—
  - 1) a ball is being bowled and the arm straightens or bends during the delivery. If the arm is bent all the way through the delivery, it is a legal delivery. The umpire must be completely satisfied with the absolute fairness of a delivery.
  - 2) at the point of delivery, the back foot is on or outside the bowling / return crease.
  - 3) the ball bounces more than twice, before reaching the batter.
  - 4) at the point of delivery, there are more than two fielders behind the batter on the leg side. On the line is considered in the offending half.
  - 5) a fielder or part of a fielder is on the pitch prior to the ball being played at or played by the batter.
  - 6) the bowler changes their style or direction of run up without informing the umpire, e.g. round the wicket delivery, to over the wicket delivery. The umpire must make the batter aware of any such changes.
  - 7) the wicketkeeper takes the ball in front of the stumps, the ball not having touched the batter or their bat.
  - 8) the wicketkeeper cannot have the gloves in front of the line of the stumps as the ball is delivered.
- b. A no-ball is an additional two runs, plus the number of runs scored off that no-ball, to the batting side.
- c. A maximum of 2 balls shall be re-bowled [max 8 balls in an over].
- d. Batters can only be dismissed off a no-ball by way of a run-out, or interference.

### Law 6: Field Placement

- a. There shall be no more than two fielders behind the batter on the leg side [on side].
- b. Fielders close to the wicket may not move in such a manner as to disturb the batter, until the batter has played the ball.
- c. The ball is considered bowled once it has left the bowler's hand, and moved forward of the bowling crease.
- d. There shall be no fielder, or part of a fielder, other than the bowler on, or extending over the pitch until the ball has been played at or played by the batter.
- e. If a, b, c or d is contravened; the umpires shall call "no-ball."

### Law 7: Scoring

Runs may be scored as follows:

- a. Every time the batters cross between the batting crease and the running creases while the ball is in play, 1 run is scored.
- b. Overthrows are counted as runs.
- c. When the ball reaches or is hit over the agreed boundaries, 4 and 6 runs respectively are scored.
- d. Two bonus runs are scored for a no-ball or wide.



---

**CRICKET****Law 8: Wides**

- a. A wide shall be called if, as the ball crosses the batting crease, it is not touched by the batter's bat or person and in relation to painted lines either side of the wickets—
  - 1) It passes on the batter's off side and is on or wide of the off side line as marked on the pitch,
  - 2) It passes on the batter's leg side and is on or outside of the leg side line as marked on the pitch. Note, the ball must clearly pass down the leg side of the batter; and any ball passing between any part of a batter and the wicket is not wide.
  - 3) Is higher than the batter's shoulder at normal stance, or chest height when the batter is standing upright, as it crosses the batting crease.
- b. A wide does not count as part of an over, and two runs shall be added to the batting score.
- c. A batter may be dismissed off a wide ball only by way of - hit wicket, run-out, stumped, handled ball or obstruction on the field.
- d. A wide ball shall be counted as a no-ball— see Law 5: 8b and c.

**Law 9: Appeals for Dismissals**

- a. The umpire shall not give the batter out unless appealed to by the opposing team. Such an appeal must be made immediately.
- b. An appeal shall cover all forms of dismissals.
- c. An appeal must be made in the form of a verbal question to the umpire.
- d. The umpire's decision is final. The umpire may alter a decision, provided such alteration is done promptly.

**Law 10: Striking the Wicket in Dismissal**

- a. The batter is "out" if the ball, the batter or the batter's bat, removes one or both bails from the stumps. A disturbance of a bail does not constitute a dismissal.
- b. For a batter to be given "out" the stumps must be upright before being struck. The stumps when standing are always alive, irrespective of one or two bails being removed. If the bail has been removed during play, the stumps may be hit again and the batter given out.

**Law 11: Dismissals**

- a. Only one batter may be given out in a play.
- b. A batter may be dismissed when they are:
  - 1) Bowled  
After being bowled to, the ball hits the batter's stumps and dislodges one or both bails. The ball may touch the batter or bat before hitting the stumps.
  - 2) Caught
    - a) Any ball that touches the bat or the hands touching the bat [from the wrist down] and the ball is held by a fielder before touching the ground. The batter is still given out, if the ball touches the batter immediately before or after touching the bat.
    - b) The ball may be caught off any fielder except a direct hit for six. If the ball touches a fielder's person and then goes over the boundary on the full, a six shall be scored, and the batter is "not out."
    - c) If the fielder catches the ball and runs over the boundary, the batter shall be given "not out" and six runs scored.

Note: If the ball strikes the non-striker's bat or person, and the ball is held by a fielder, the batter shall be given "not out."



## CRICKET

### 3) Stumped

The batter may be out “stumped” when the wicketkeeper takes the ball and breaks the wicket and the batter is out of their ground. Should the wicketkeeper take the ball in front of, and in line with the stumps, it will be a “no ball” and the batter cannot be stumped. The wicketkeeper may only take the ball in front of the stumps if the ball has already hit the batter or their bat.

### 4) Run Out

At all times when the ball is alive, a batter may be run out if a fielder breaks the wicket, when the batter is out of their ground. A batter is only safe if some part of the bat [in hand] or their person is grounded behind the popping crease at the batter’s end or the bowler’s end.

### 5) Leg Before Wicket [L.B.W.]

A batter shall be given out L.B.W. if, in the opinion of the umpire, the ball pitched in line with the wicket, the batter made no attempt to strike the ball, and the ball would have hit the wickets if they had not hit the batter’s legs first of all [L.B.W.].

### 6) Hit Wicket

A batter is out when the batter hits the wicket with the bat or their person while playing the ball. A batter is not out if the batter should break the wicket while returning to the crease whether or not a run has been taken.

### 7) Interference

A batter shall be given out when:

- a) They deliberately interfere with the ball while in play.
- b) They deliberately obstruct a fielder fielding the ball; bearing in mind the fielder has the right of way as long as the fielder is fielding the ball fairly.

Note: Should any player deliberately endanger any opposition player, irrespective of the right of way provisions, the player will be dealt with under the “misconduct and penalties” rule.

### Law 12: Misconduct and Penalties

- a. Any bad language, arguing with umpires, unduly rough play, time wasting, mistreatment of equipment, unsportsmanlike behavior or gestures made by players or their team officials, will incur an immediate penalty of 5 runs. An athlete’s failure to comply with the umpire’s request may result in the player’s expulsion from the pitch and/or game, or further penalty of 5 runs.
- b. Any game may be stopped and awarded to either team if infringements of the nature escalate to the point where the game is no longer under the control of the umpires.
- c. All penalties are deducted from the team’s batting score.
- d. The coaches and captains are responsible at all times for ensuring that play is conducted within the spirit of the game and rules.
- e. The umpires are the sole judges of fair and unfair play.
- f. The umpire shall intervene, without appeal, in the event of unfair play. During such intervention the ball shall be “dead.”
- g. The umpire has the right to stop the game should they consider that the situation, outside the pitch area is not conducive to the competitive spirit of the games. The game shall only be restarted when these conditions have been met.
- h. Penalties relating to the conduct of all participants shall be under the jurisdiction of the management/Tournament Committee.



---

**CRICKET****Law 13: Championship Scoring**

The results and points systems will be decided by the Organizing or Tournament Committee.

**Law 14: Playing Area Layout and Dimensions**

- a. The wicket is the area between the bowling, batting and return creases.
- b. The stumps shall be of equal and sufficient size to prevent the ball passing through them. Their tops shall be 71.1 cm above the ground.
- c. The bails shall be 11.1 cm in length and when in position shall not extend more than 1.3 cm beyond the stump.
- d. Two sets of wickets, each 22.86 cm wide, and consisting of three stumps with two bails on the top, shall be pitched opposite to each other, 20 m / 22 yd apart.
- e. The wicket line shall be marked in line with the stumps at each end, and shall be 1.83 m in width, with the stumps in the centre, and the centre stumps 20 m / 22 yd apart.
- f. The popping crease, which is the back edge of the of the crease marking, shall be in front of, and parallel with, the wicket lines at both ends. It shall have its back edge 1.22 metres from the centre of the stumps. At the batter's end it shall extend from one side of the wicket to the other and shall be called the batting crease. At the bowler's end it shall be the same length as the wicket line and it shall be called the bowler's crease or front foot line.
- g. The return crease at both ends shall be at right angles to the wicket line and shall extend from the wicket line to the popping crease. Where a return crease marking is used, it shall be the inside edge of that marking. Where a clearly contrasting pitch color is used, it may be the edge of the pitch.
- h. All players must abide by the rules and regulations.

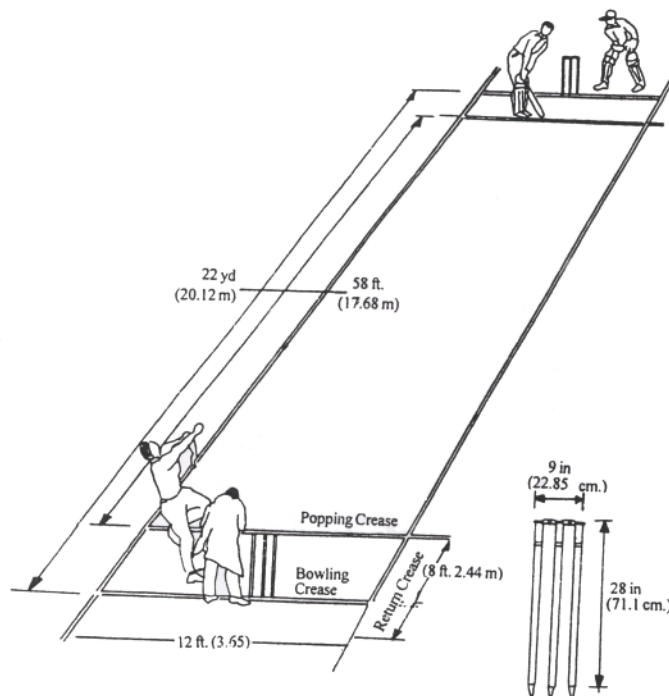



## CRICKET

### Law 15: Basic Rules

- a. The team list must be registered before the game, and cannot be changed unless there is an injury/illness, and agreed to by the opposing coach/captain.
- b. The value of the boundaries shall be as in regulation Cricket.
- c. The ball to be used will be decided by the Organizing/Tournament Committee.
- d. It is recommended that all players wear the following playing uniform and protective equipment—
  - 1) The players shall wear their standard cricket uniform
  - 2) Long trousers are recommended
  - 3) Proper sports footwear must be worn
  - 4) Cricket pads must be worn by the batters and the wicketkeeper pads by the wicketkeeper
  - 5) Protective box/abdomen guard for males and protective chest padding for females must be worn while batting, for health and safety reasons.
  - 6) Batting gloves must be worn by the batters and wicketkeeper gloves by the wicketkeeper
  - 7) Wearing of the protective helmet is recommended for all batters

### UMPIRES SIGNALS

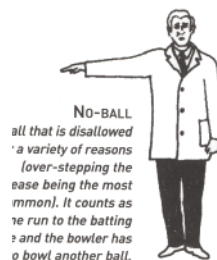
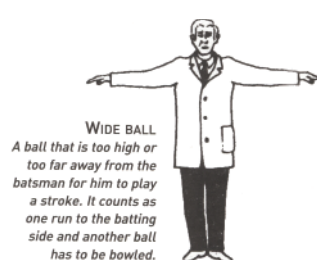
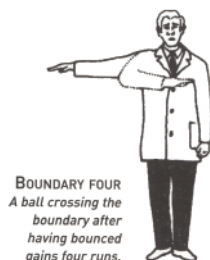
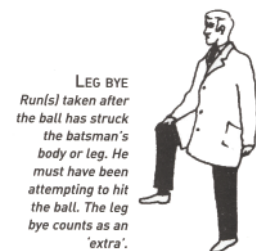
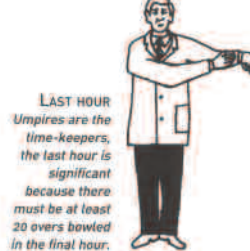
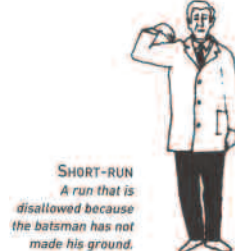
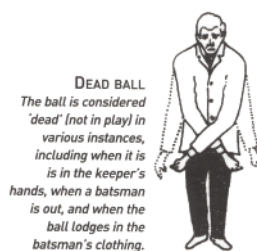
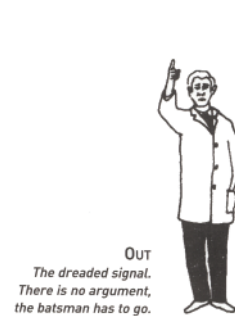
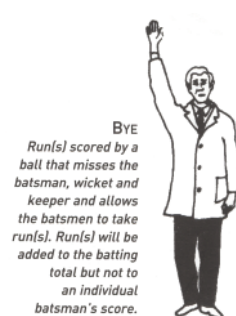
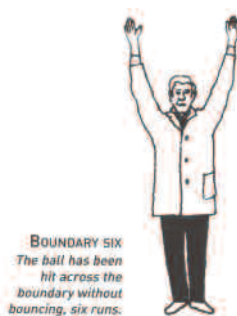



---

**CRICKET****SECTION 3 — CRICKET SKILLS TEST**

Before pre-competition divisioning games can take place, the event organizers should receive a Cricket Team Score for each of the teams participating

The Cricket Team Score is worked out as the average of the eight best individual scores from the Cricket Skill Tests

The Cricket Skill Tests will comprise Five Skill Tests—

Batting

Bowling

Fielding -Throwing

Fielding -Catching

Fielding -Stopping the Ball

Ideally, these Cricket Skill Tests should all take place on a Cricket field, with the players properly dressed and using the proper Cricket equipment.

Cricket Uniform—all players should wear shorts or long trousers, a shirt and sports shoes; a cricket/baseball cap is optional.

Cricket Ball = full-sized ball, 2 or 4 piece, weighing 156 to 163 grams /5 1/2 to 5 3/4 oz.

Safety: When the players are batting they must wear a batting pad on each leg, batting gloves and a protective box/abdomen guard for males, and protective chest padding for females.

The wearing of a Cricket Helmet is optional, but in the event of a batting side facing a fast bowler, a helmet should be offered to all batsmen.

The person acting as the Wicket Keeper for the Fielding—Throwing Test should wear full protective gear.

**CRICKET SKILL TESTS****1. Batting**

We are looking for the batter to:

- a. watch the bowler as they run up
- b. lift the bat as the bowler is about to deliver
- c. move the feet into position to play a shot
- d. move the bat towards the ball
- e. hit the ball

**2. Bowling**

We are looking for the bowler to:

- a. run up smoothly to the bowling crease
- b. make a legal delivery in both the bowling action and in their placement of the front foot
- c. bowl accurately towards the wicket at the other end



## CRICKET

### 3. Fielding

We are looking for three different skills in the fielding

- a. Throwing—for accuracy and distance
- b. Catching—at waist level and from a high lob
- c. Stopping the Ball/Defending the Boundary—ball rolled to three different distances

Note: Each Skill Test has 6 performances - with a maximum of 3 points for each performance.

**Maximum Skill Test Score = 18 points**

There are 5 Skills Tests, each with a maximum of 18 points. **Maximum Individual Total Score = 90 points.**

### CRICKET SKILL TEST 1 — BATTING

Description of the Batting Skill Test

1. Before the test begins, the players should be told what three skills you are looking for =
  - a. Lifting the bat and moving it towards the ball
  - b. Moving the feet
  - c. Hitting the ball
2. The tester/bowler—standing at the bowling crease - will “throw down” 6 balls towards the batter standing in their crease and dressed in full cricket uniform.
3. Before each ball, the tester will check that the batter is ready by asking—“Are you ready?”
4. Each ball should be thrown so that the ball lands at the most, 3 metres in front of the batter. Any ball not landing in the designated area will not count as one of the batters’ 6 balls they must receive—see diagram
5. The speed of the ball should not be too fast or too slow—but should duplicate the speed a “medium paced bowler” will bowl in a game—see diagram

### BATTING SCORING TABLE

Points	Skills
3	Lifts bat on delivery, moves feet, swings bat towards the ball, and hits the ball
2	Lifts bat on delivery, moves feet, swings bat but misses the ball
1	Swings bat and hits or misses the ball
0	Does not move bat or feet or swing at the ball

Note: A batter cannot score 3 or 2 points if they do not move their feet, but just swing the bat. Foot movement in this skill test is essential.



# CRICKET

## BATTING SKILL TEST DIAGRAM

Bowler can bowl from either the right or the left side of the wicket, in the bowling crease.

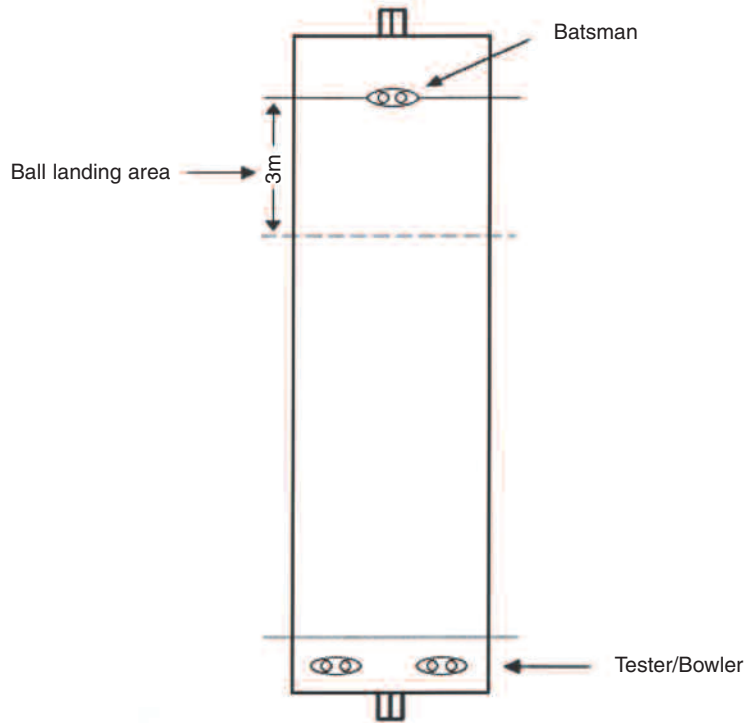

Ball delivery with medium pace

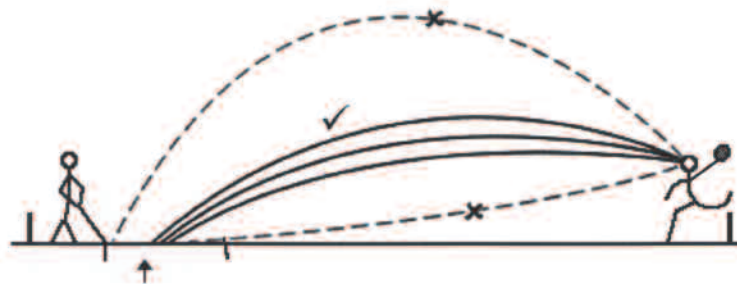

Ball landing area

x - Not Correct

✓ - Correct



## CRICKET

### CRICKET SKILL TEST 2— BOWLING

#### Description of the Bowling Skill Test

1. Before the test begins, the players should be told what three skills you are looking for =
  - a. Smooth run up to the bowling crease
  - b. Legal bowling action and legal delivery [coach should demonstrate these to the players]
  - c. Accurate delivery to the stumps at the other end
2. The length of the pitch may vary in each of the programs but ideally it should be between 18 to 20 metres in length.
3. Description of the Target Wicket:
  - a. At the **Target Wicket**, place marker cones or chalk lines, 0.5 metre and 1 metre to either side of the set of wickets— providing a 1 metre target zone either side of the wicket.
  - b. See diagram

Note 1: The Testers/Umpires will position themselves in the normal umpiring positions— one behind the wicket at the bowler's end, and the second at right angles to the wickets at the batter's end, so that they can both judge the line and height of the ball as it passes the batters' wickets.

Note 2: Inner Zone = area inside cone/chalk line 0.5m either side of wickets

Outer Zone = area inside cone/chalk line 1m either side of wickets

#### BOWLING SCORING TABLE

Points	Skills
3	No more than 2 bounces and ball finishes inside the Inner Zone [0.5m either side of wicket]
2	No more than 2 bounces and ball finishes inside the Outer Zone [1m either side of wicket]
1	No more than 2 bounces but ball finishes outside the Outer Zone
0	3 or more bounces and/or ball finishes outside the Outer Zone

Note: A good cricketer should be scoring 2 or 3 points for most deliveries; anyone scoring 0 points, may not have the necessary skills to play Cricket yet.

Question: How do we assess full tosses?

Answer: They are legal\* but dangerous if they are bowled at the head and upper body of a batter

A full toss that is more than 1.5 metres above the ground at the batters end, as it passes over the wickets, is NOT counted and may be bowled again.

\* The decision on whether a full toss is legal or dangerous will be made by the Skills Tester, who will be standing in the Umpire's position at the bowler's end



---

## CRICKET

### BOWLING SKILL TEST DIAGRAM

Bowler can bowl from either the right or the left side of the wicket, in the bowling crease.

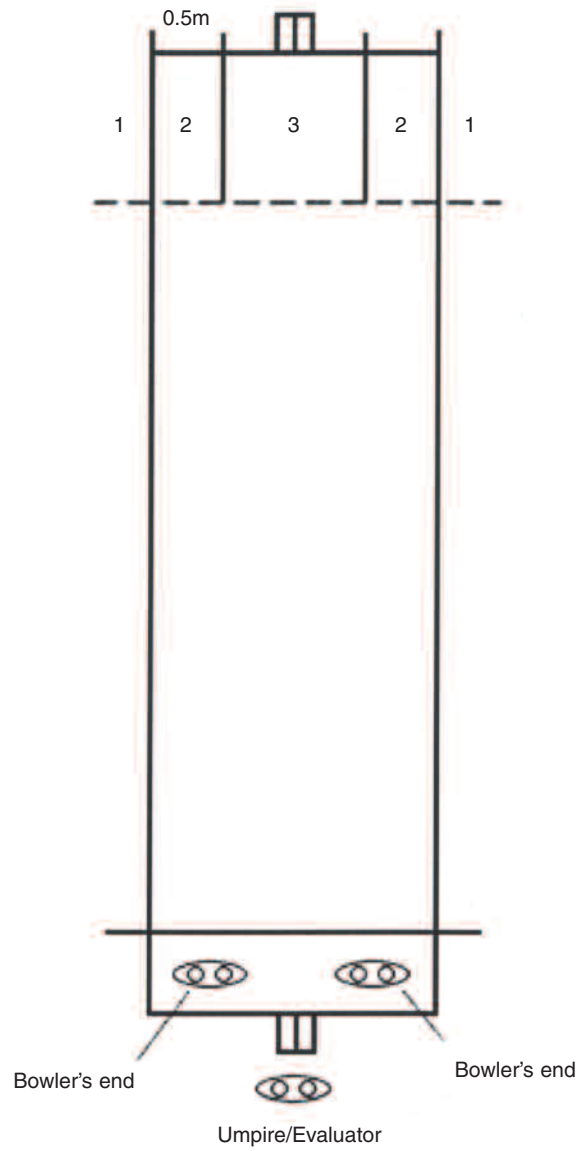



## CRICKET

### CRICKET SKILL TEST 3 — FIELDING-THROWING

Description of the Fielding — Throwing Skill Test

1. There are two basic type of throws needed in Cricket =
  - a. Short accurate throw to the wicketkeeper from the close fielders
  - b. Long throw from the outfield to the wicket or another closer player
2. Each player will be asked to demonstrate three throws for accuracy, and three throws for distance
3. Accuracy Skill Test
  - a. From 15 metres away from the wicket, with a Wicket Keeper, dressed in full protective gear, standing in the middle of the centre circle, the fielder will have 3 throws to be caught by the Wicket Keeper — see diagram.

ACCURACY SCORING TABLE — see diagram

Points	Skills
3	Ball thrown to wicket keeper's gloves, and ball is caught/touched by gloves within their arms length, with no feet movement towards the ball = Zone 1
2	Ball thrown to wicket keeper's gloves with wicket keeper taking no more than a step to the left or right of the wicket to catch/retrieve/stop the ball = Zone 2
1	Ball thrown to wicket keeper's gloves with wicketkeeper taking up to 2 steps to the left or right of the wicket to retrieve the ball = Zone 3
0	Ball does not reach wicket keeper's gloves at all, or thrown very wide of wicket keeper — Outside Zone 3



**CRICKET**

**FIELDING — THROWING SKILL TEST FOR ACCURACY DIAGRAM**

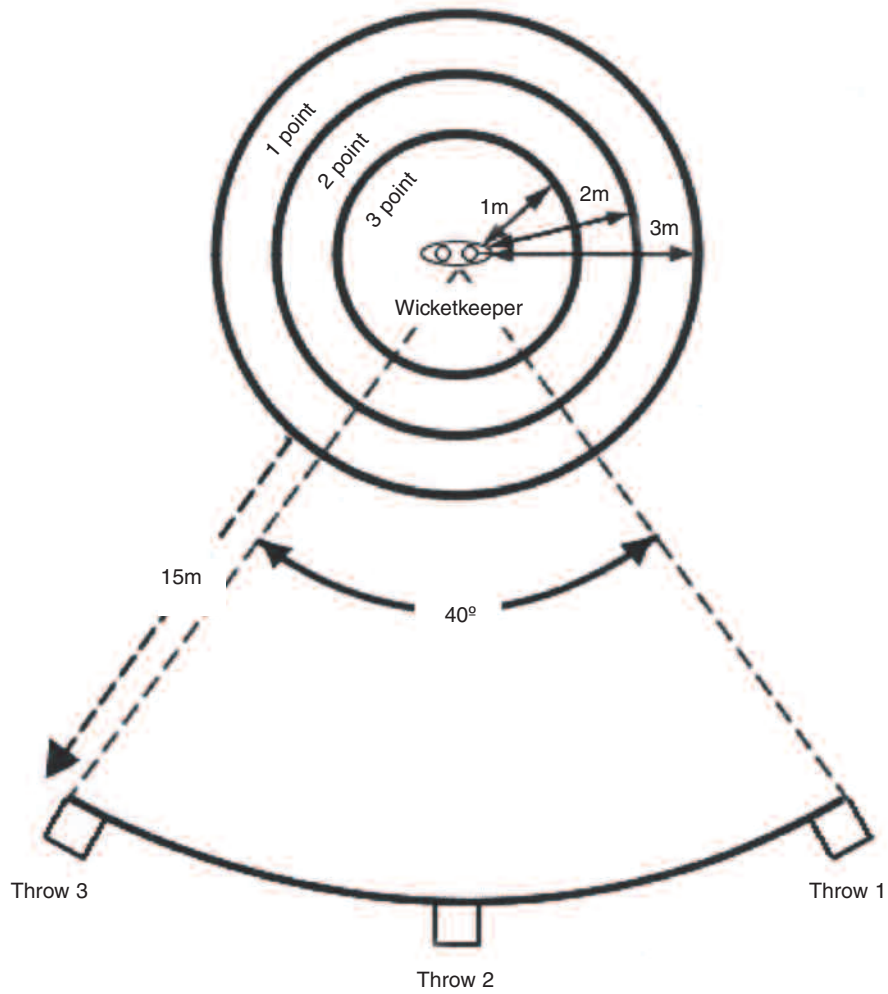

Inner Circle: 1m Radius  
Middle Circle: 2m Radius  
Outer Circle: 3m Radius



## CRICKET

### 4. Distance Skill Test

- a. Use the throwing arcs designated at 40°, and mark off arcs at 20m, 30m and 40m—see diagram
- b. From behind a line on the ground, a player may stand at the line or run up to the line, and throw the cricket ball as far as they can in a forward direction, inside the 40° landing area.

### DISTANCE SCORING TABLE [MALE ONLY]—see diagram

Points	Skills
3	Ball landing beyond the 40m arc—BEYOND Zone 3
2	Ball landing between the 30m and 40m arcs—Zone 3
1	Ball landing between the 20m and 30m arcs—Zone 2
0	Ball landing between throwing line and 20 m arc—Zone 1

Note: A good cricketer should be scoring 2 or 3 points for most throws; anyone scoring 0 points, may not have the necessary skills to play Cricket yet.



**CRICKET**

**FIELDING — THROWING SKILL TEST FOR DISTANCE DIAGRAM**

Thrower will throw three balls, as far as they can, from behind the line within the 3 x 2 metre box.

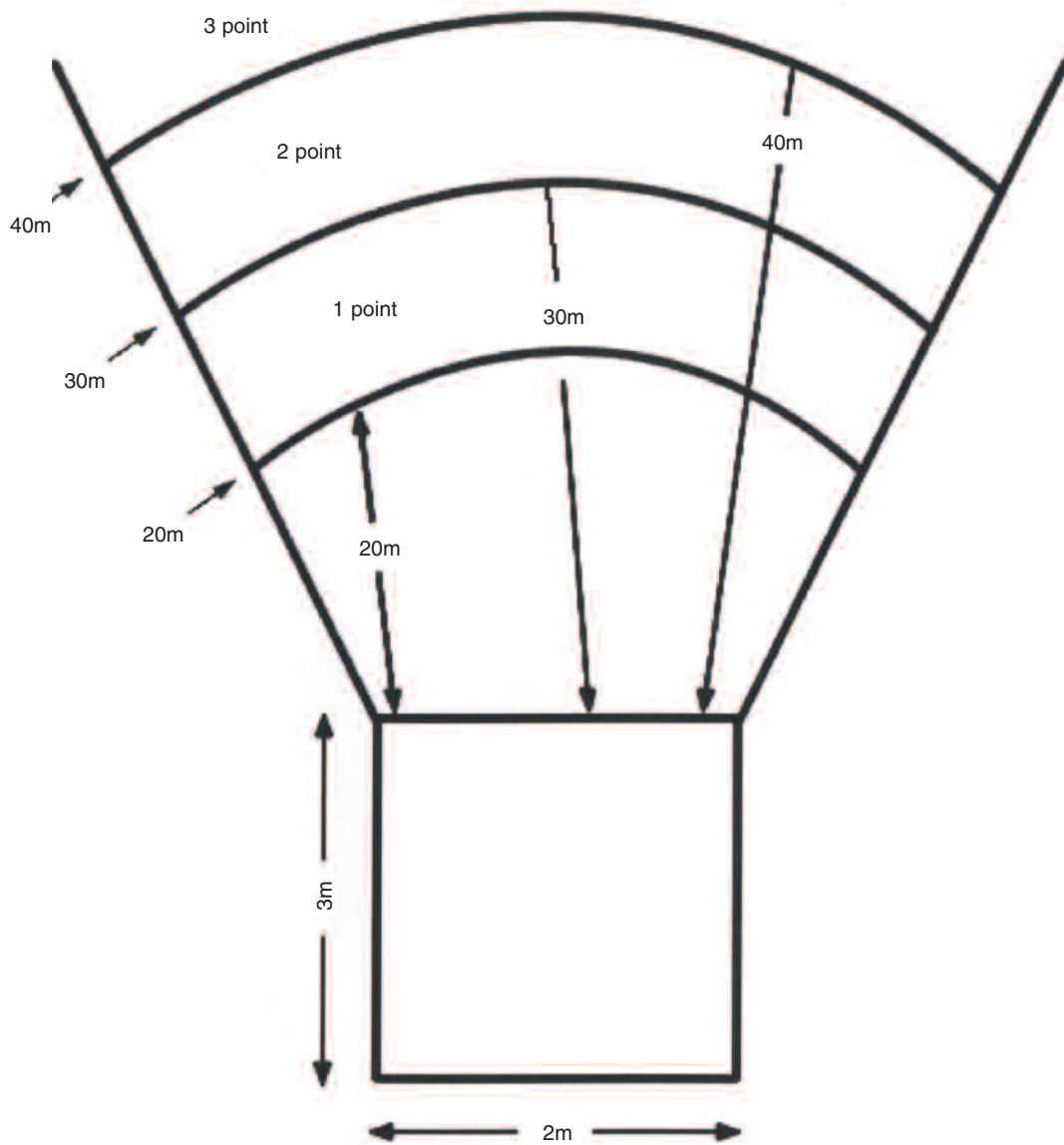



## CRICKET

### CRICKET SKILL TEST 4 — FIELDING-CATCHING

#### Description of the Fielding – Catching Skill Test

1. There are two basic types of catches that are taken in Cricket =
  - a. Catch taken around waist height by the slips, the wicket keeper and close in fielders.
  - b. Catch taken in the outfield from a lofted shot
2. Each player will be asked to demonstrate their ability to catch three balls at their waist height, with the ball thrown underarm to them from 5 metres.
3. Each player will be asked to demonstrate their ability to catch THREE balls tossed up in the air towards them, with an underarm action to a height of 10 to 15 metres off the ground.
4. Before throwing each ball, the tester will check that the fielder is ready to catch the ball by asking —“Are you ready?”

#### CATCHING SCORING TABLE — see diagram

Points	Skills
3	Watches ball, moves body behind ball, hands ready to catch and catches the ball
2	Watches ball, moves body behind ball, but drops the catch
1	Attempts to catch ball, but drops ball
0	Does not move, watch or catch ball

Note: A good cricketer should be scoring 2 or 3 points for most catches; anyone scoring 0 points, may not have the necessary skills to play Cricket yet.



---

**CRICKET****FIELDING — CATCHING SKILL TEST DIAGRAM**

Ball thrown overhead to the catcher, who starts from the back of the 3 metre circle.

Tester will throw ball in an underarm motion from the 15 metre line.

Ball thrown to the catcher's waist height, from the 5 metre line, with the starting position of the catcher in the centre of the 2 metre circle.

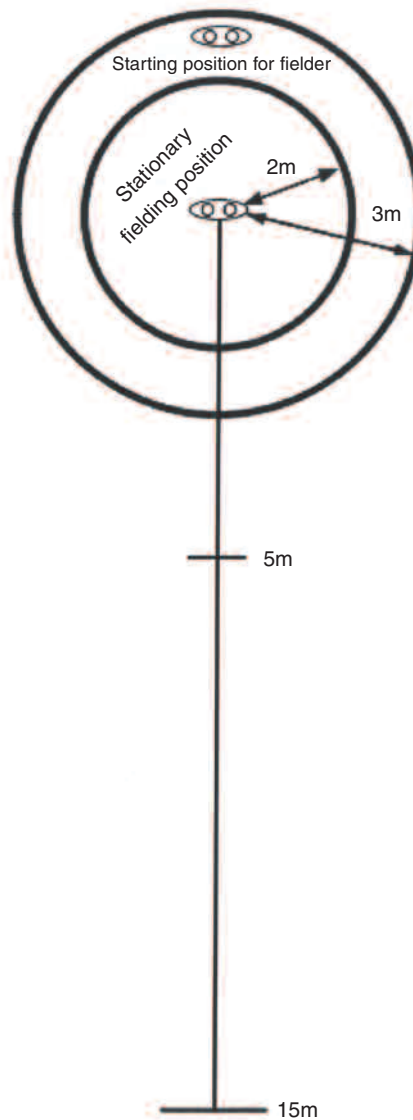



## CRICKET

### CRICKET SKILL TEST 5 FIELDING — STOPPING THE BALL

Description of the Fielding — Stopping the Ball/ Defending the Boundary Skill Test

1. Each player will be asked to stop cleanly, 2 balls rolled along the ground towards them from each of the three distances of 10 metres, 20 metres and 30 metres.
2. The Tester will roll the ball, with an underarm action, along the ground towards the fielder — and will position himself in the Throwing Box, with the fielder standing alongside an arc marked at first 10m, then 20m and finally 30 metres.
3. Each ball must be rolled at such a speed that it is still moving when it reaches the fielder, so that the fielder can demonstrate their ability to stop the ball cleanly.
4. Coaches can also encourage the accurate throwing of the ball back to the Tester or Wicket Keeper after the fielder has stopped the ball.

### STOPPING THE BALL SCORING TABLE

Points	Skills
3	Body behind the ball, watches the ball as it travels along the ground towards them and stops it cleanly
2	Body not right behind the ball, but stops the ball cleanly
1	Body not behind the ball, and has trouble stopping and collecting the ball
0	Does not move towards the ball, or stop the ball at all

Note: A good cricketer should be scoring 2 or 3 points for most stops; anyone scoring 0 points, may not have the necessary skills to play Cricket yet.



---

**CRICKET****FIELDING — STOPPING THE BALL/ DEFENDING THE BOUNDARY SKILL TEST DIAGRAM**

Tester will roll two balls, from the 3 x 2 metre square, to the athlete who will be starting out at one of three position on the field (inside the 10 metre line, inside the 20 metre line then inside the 30 metre line.) The athlete is told to field the ball as if they are recovering the ball that has been hit, while at the 10 metre and 20 metre lines. The athlete is told to defend the boundary while starting out at the 30 metre line.

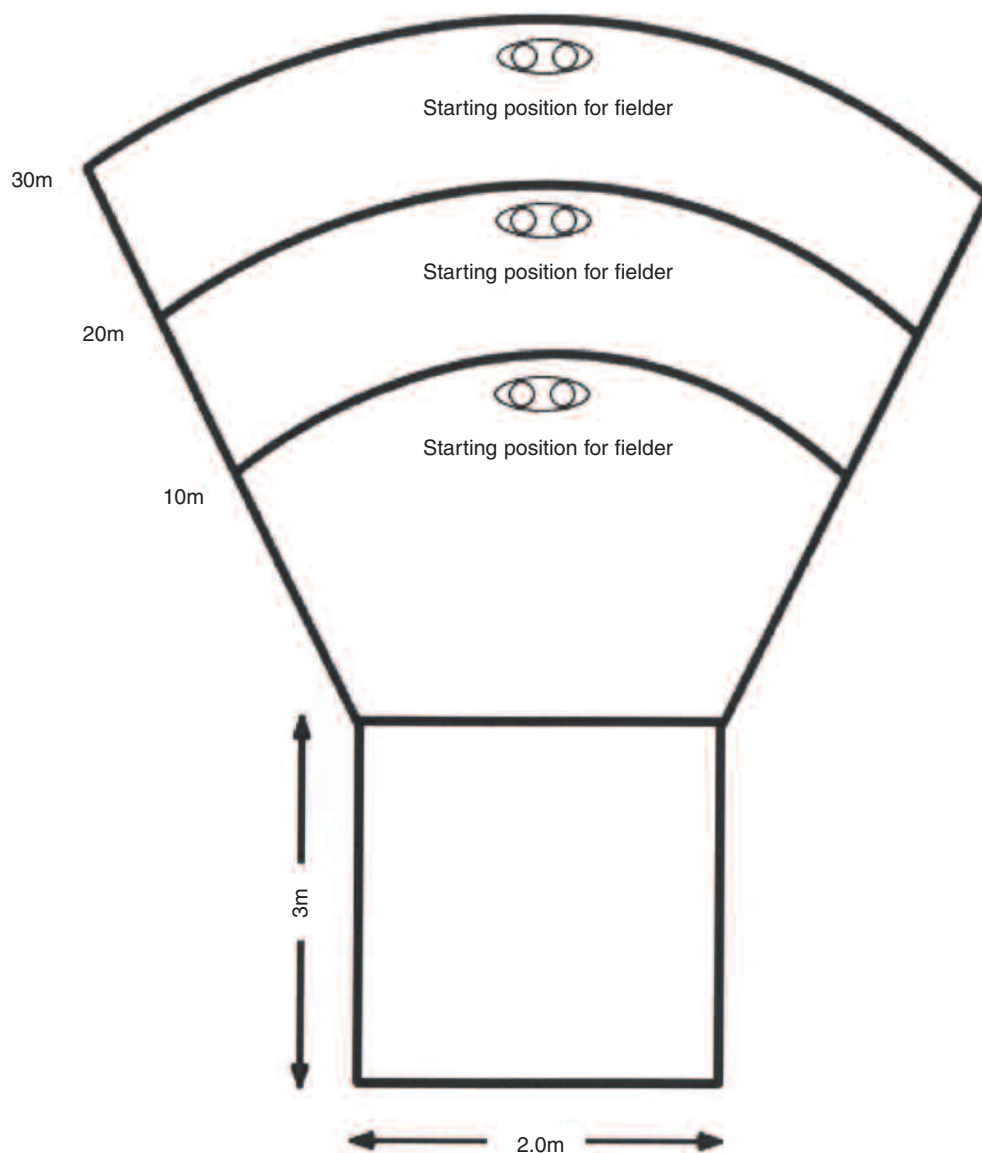



**CRICKET**

**Special Olympics Cricket Scoresheet**

BATTING TEAM = \_\_\_\_\_ FIELDING TEAM = \_\_\_\_\_

#	NAMES OF BATTING TEAM	OVER 1	OVER 2	OVER 3	OVER 4	TOTALS
#1						Runs Wkts
#2						
#3						
#4						
#5						
#6						
#7						
#8						
#9						
#10						
#11						
TOTAL RUNS =						
TOTAL WICKETS =						
BATTING TEAM SCORE =						
		RUNS / WICKETS =		GAME WINNER =		

BATTING TEAM = \_\_\_\_\_ FIELDING TEAM = \_\_\_\_\_  
 Captain: \_\_\_\_\_ Match Referee: \_\_\_\_\_  
 Head Coach: \_\_\_\_\_ Head Coach: \_\_\_\_\_